

GARDEN WINDOW

Price List

2024



RENAISSANCE
CONSERVATORIES

Effective: January, 2024. Prices & specifications subject to change without notice.

PRICING: AWNING-STYLE (Top-Hinged)

4	3	5	6	7	8	9	10	11	12				13	14	15	16		
Model Number	Maximum Sleeve-Mount Rough Opening or Max. Face Mount Coverage Dimension (Width x Height)	Base Price (16" Projection, Sleeve-Mount or Face-Mount Cedar Framing, 12:12 Pitch)	Add for Custom Roof Pitch (Standard Pitch = 12:12)	Add for 24" Projection (Call for Tech Support)	Add for Shorter Rough Opening (12" Max.) (Call for Tech Support)	Add for Mounting Sleeve Extension (13-1/4" Max. Wall Thickness) (Call for Tech Support)	Add for Counter Top Extension (Call for Tech Support)	Add for Copper Roof Caps	Add for Lead-Coated Copper Roof Caps & Outside Metals	Add for Simulated Colonial Divided Lites (Inside & Outside, Front & Sides)	Add for Applied Colonial Roof Grilles (Inside Only)	Add for Simulated Prairie Divided Lites Grills (Inside & Outside, Front Only)	Add for Victorian or Gothic Arches (Inside & Outside, Front Only)	Add for Crossing Gothic Arches (Priced Per Side, Front Only)	Add for GORE™ InLighten™ Virtually Invisible Window Screens	Add for Roof Sun Screens (Available Only with Aluminum Roof Caps)	Add for Factory Prime Paint	Add for Revival Series Solid Brass/ Bronze Sash Hardware
3030A	36" x 36"	\$4,951	\$919	\$1520	\$1250	\$305	\$431	\$529	\$513	\$447	\$364	\$581	\$1186	\$1267	\$386	NA	\$523	\$1327
3040A	36" x 48"	5,180	919	1562	1250	358	431	529	513	710	364	605	1186	1267	312		523	1327
3050A	36" x 60"	5,419	919	1600	1250	411	431	529	513	814	364	629	1186	1267	338		523	1327
3060A	36" x 72"	6,671	919	1637	1250	465	431	529	513	808	364	653	1186	1267	363		523	1327
4030A	48" x 36"	5,193	919	1599	2179	358	442	558	554	519	376	605	1186	1267	307		523	1327
4040A	48" x 48"	5,574	919	1643	1279	411	442	558	554	824	376	629	1186	1267	342		523	1327
4050A	48" x 60"	5,844	919	1694	1279	479	442	558	554	969	376	653	1186	1267	376		523	1327
4060A	48" x 72"	6,104	919	1731	1279	532	442	558	554	993	376	677	1186	1267	410		523	1327
5030B	60" x 36"	6,452	944	1732	1323	426	469	542	668	626	417	638	1372	1534	354		638	1354
5040B	60" x 48"	6,901	944	1778	1323	479	469	542	668	802	417	886	1372	1534	397		638	1354
5050B	60" x 60"	7,072	944	1844	1323	561	469	542	668	1077	417	934	1372	1534	340		638	1354
5060B	60" x 72"	7,251	944	1881	1323	614	469	542	668	1368	417	982	1372	1534	383		638	1354
6030B	72" x 36"	6,951	944	1823	1352	479	480	571	709	858	448	989	1372	1534	372		638	1354
6040B	72" x 48"	7,220	944	1886	1352	546	480	571	709	1005	448	1110	1372	1534	423		638	1354
6050B	72" x 60"	7,415	944	1937	1352	614	480	571	709	1352	448	1158	1372	1534	474		638	1354
6060B	72" x 72"	7,903	944	1203	1352	696	480	571	709	1603	448	1186	1372	1534	526		738	1354
9030C	108" x 36"	8,391	969	1210	1464	653	440	816	808	830	491	1143	1559	1802	458		853	1981
9040C	108" x 48"	9,069	969	1593	1464	734	440	816	808	1131	491	1215	1559	1802	536		853	1981
9050C	108" x 60"	9,618	969	1872	1464	830	540	816	908	1532	491	1387	1559	1802	614		853	1981
9060C	108" x 72"	9,875	969	1824	1464	898	540	816	908	1801	491	1459	1559	1802	689		853	1981
10030C	120" x 36"	9,172	969	1953	1492	720	551	846	948	921	424	1567	1559	1802	621		853	1981
10040C	120" x 48"	9,578	969	2288	1492	802	551	846	948	1424	424	1639	1559	1802	626		853	1981
10050C	120" x 60"	10,844	969	2367	1492	898	551	846	948	1926	424	1711	1559	1802	728		853	1981
10060C	120" x 72"	12,117	969	2433	1492	980	551	946	1048	2285	424	1883	1559	1802	830		883	1981

Standard Features Included:

- Custom Sized to Fit Your Opening
- Factory Assembled
- Cedro (Spanish Cedar) Framing
- High Performance Low-E-Glass
- Operating Sash with Screens
- Adjustable Plant Shelves
- Decorative Corbel Supports
- Copper Drip Tray

GRID & ARCH OPTIONS SECTION

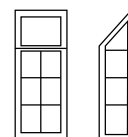

A. (One Operable Awning)

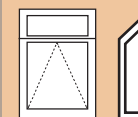

1 Motorized Sash:
Add \$1698

B. (Two Operable Awnings)

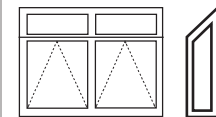

2 Motorized Sash:
Add \$3,396

C. (Three Operable Awnings)

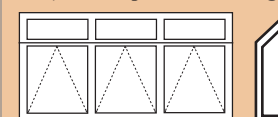

3 Motorized Sash:
Add \$4,094

SIMULATED COLONIAL DIVIDED LITES (Inside & Outside)

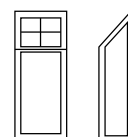

APPLIED COLONIAL ROOF GRILLES (Inside Only)

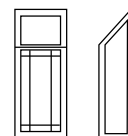

SIMULATED PRAIRIE DIVIDED LITES (Inside & Outside)

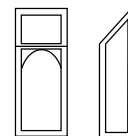

VICTORIAN ARCHES (Inside & Outside)

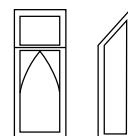

GOTHIC ARCHES (Inside & Outside)

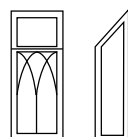

CROSSING GOthic ARCHES (Inside Only)

(Optional Inside & Outside)

PRICING: CASEMENT-STYLE (Side-Hinged)

4040D	48" x 48"	\$6,957	\$944	\$1680	\$1295	\$411	\$458	\$509	\$424	\$598	\$386	\$562	\$1372	\$534	\$372		\$538	\$1654
4050D	48" x 60"	7,209	944	1731	1295	479	458	509	424	778	386	710	1372	534	406		538	1654
4060D	48" x 72"	7,468	944	1768	1295	532	458	509	424	933	386	858	1372	534	440		538	1654
6040E	72" x 48"	8,233	969	1896	1378	546	507	522	579	790	328	843	1559	802	458		753	1981
6050E	72" x 60"	8,836	969	1947	1378	614	507	522	579	1065	328	915	1559	802	509		753	1981
6060E	72" x 72"	8,993	969	2013	1378	696	507	522	579	1244	328	987	1559	802	560		753	1981
8040F	96" x 48"	9,942	994	2197	1514	681	508	735	733	981	375	1125	1745	1069	644		968	2308
8050F	96" x 60"	11,994	994	2248	1514	749	508	835	733	1328	375	1220	1745	1069	712		968	2308
8060F	96" x 72"	12,731	994	2328	1214	845	608	935	733	1555	375	1316	1745	1069	780		968	2308

D. (Two Operable Casements)

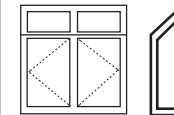

E. (Three Operable Casements)

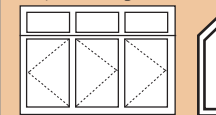

F. (Four Operable Casements)

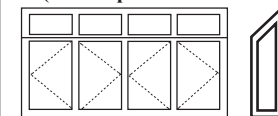

Garden Window Help Line: 1-800-882-4657 (Mon. - Fri. 9-5 Eastern Time)

GARDEN WINDOW ORDER FORM

ORDERING IS AS EASY AS **1 2 3**

STEP 1

Circle the preferred **Operable Window Style** (below) and check the appropriate box **1** (right).

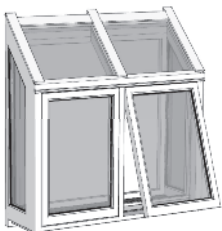

Viewed From Outside

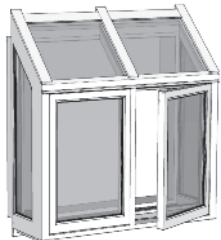

CASEMENT STYLE (Side-Hinged)

AWNING STYLE (Top-Hinged)

STEP 2

Circle the suitable **Mounting Style** (below), check the appropriate box **2** (right), select and complete the appropriate detail **A B C D**, and submit the Detail Sheet with this Order.

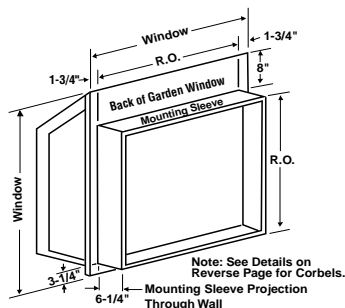

Viewed From Inside

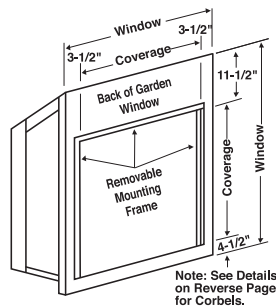

Note: See Details on Reverse Page for Corbels.

SLEEVE-MOUNT

The back of your Garden Window will have a built-in Mounting Sleeve that will "slide" into your window opening. The Mounting Sleeve will go through your wall a maximum of 6-1/4". If your wall is thicker than 6-1/4", we offer a Mounting Sleeve Extension **9** for a wall thickness up to 13-1/4".

FACE-MOUNT

The back of your Garden Window will have a Removable (3-sided) Mounting Frame which attaches to the outside of your house wall. Your window "hangs" on the Mounting Frame and "surrounds" your existing window opening. We can make your Face-Mounted Garden Window down-in-size to barely clear your window opening, or you can keep the larger standard size to enjoy added space.

STEP 3

Measure your old window or measure your new window opening and compare your dimensions with the dimensions on the **3** Pricing Chart. Select the **4** Model Number that is larger than your window opening to determine your **5** Base Price. We will custom build your Garden Window to fit your exact opening dimension.

Garden Window Help Line: 1-800-882-4657 (Mon. - Fri. 9-5 Eastern Time)

Mail To: **RENAISSANCE CONSERVATORIES**
132 Ashmore Drive, Leola, PA 17540
Fax To: 717-661-7727

The Buyer

Ship To

Company _____ Company _____
 Name _____ Name _____
 Address _____ Address _____
 City _____ State _____ ZIP _____ City _____ State _____ ZIP _____
 Phone _____ - _____ - _____ Fax _____ - _____ - _____ D. Phone _____ - _____ - _____ E. Phone _____ - _____ - _____
 Email _____ Email _____

Will this Garden Window be installed at an elevation exceeding 5,000 feet above sea level? Yes No

- 1** Operable Window Style: Awning Style Casement Style
2 Mounting Style: Sleeve-Mount **A** Face-Mount **B**
 Sleeve-Mount Counter Top Extension **C** Face-Mount Counter Top Extension **D**

3 Size: (Refer to and complete the appropriate Detail Sheet(s), and submit with this Order.)

For Sleeve-Mount: **a** Rough Opening Width _____ **b** Rough Opening Height _____

c Total Wall Thickness _____

For Face-Mount: **a** Coverage Width _____ **b** Coverage Height _____

4 Model Number: _____ **5** Base Price \$ _____

6 Add for Custom Roof Pitch **E** [a] Specify Roof Pitch _____ \$ _____

7 Add for 24" Projection \$ _____

8 Add for Shorter Rough Opening **F** (12" maximum) (Call for Technical Support) \$ _____

9 Add for Mounting Sleeve Extension Total Finished Wall Thickness _____ \$ _____

10 Add for Counter Top Extension (Call for Technical Support) Counter Thickness _____ \$ _____

11 Add for Copper Roof Caps & Outside Metals Lead-Coated Copper Roof Caps & Outside Metals \$ _____

12 Add for Simulated Colonial Divided Lites Simulated Prairie Divided Lites: 5/8" 7/8" \$ _____

Applied Colonial Roof Grilles: 5/8" 7/8" \$ _____

Victorian Arches Gothic Arches Crossing Gothic Arches \$ _____

13 Add for GORE™ inLighten™ Virtually Invisible Window Screens \$ _____

14 Add for Roof Sun Screens Aluminum Frame & Track Color: Bronze White \$ _____

15 Add for Factory Prime Paint Inside Only Outside Only Both Inside and Outside \$ _____

16 Add for _____ \$ _____

17 Add for _____ \$ _____

Sub-Total \$ _____

\$ _____

18 FINISHES SECTION

Framing: Cedro Western Red Cedar* Honduran Mahogany*

* Call for price quotation.

Roof Caps & Outside Metals:

- Standard Bronze Aluminum
 Standard White Aluminum
 Optional Copper
 Optional Lead-Coated Copper

Terms: 50% Deposit, Balance due prior to shipment. Prices are F.O.B. Leola, Pennsylvania. Shipping will be freight collect. Prices subject to change without notice. Your Garden Window will be made to order and will take approximately 6 - 10 weeks. Your Garden Window will arrive assembled and crated, and may weigh several hundred pounds. You will need to provide the necessary manpower to remove it from the truck and transport it to your site. Shipping cost to be determined.

Tax No. on file. PA and MD Residents add 6%, NJ Residents add 7% Sales Tax

Total Order \$ _____

50% Deposit (\$ _____)

Balance \$ _____

Window Hardware, Shelf Hardware & Screens Frames:

- Bronze White Beige

Shelves: Glass Wood

Optional Revival Series Brass/Bronze Hardware Finish:

- 0125 0104 0105

Signature _____ Date _____

Method of Payment: Check/Money Order

Credit Card Account Number _____ Expiration Date _____

A SLEEVE-MOUNT

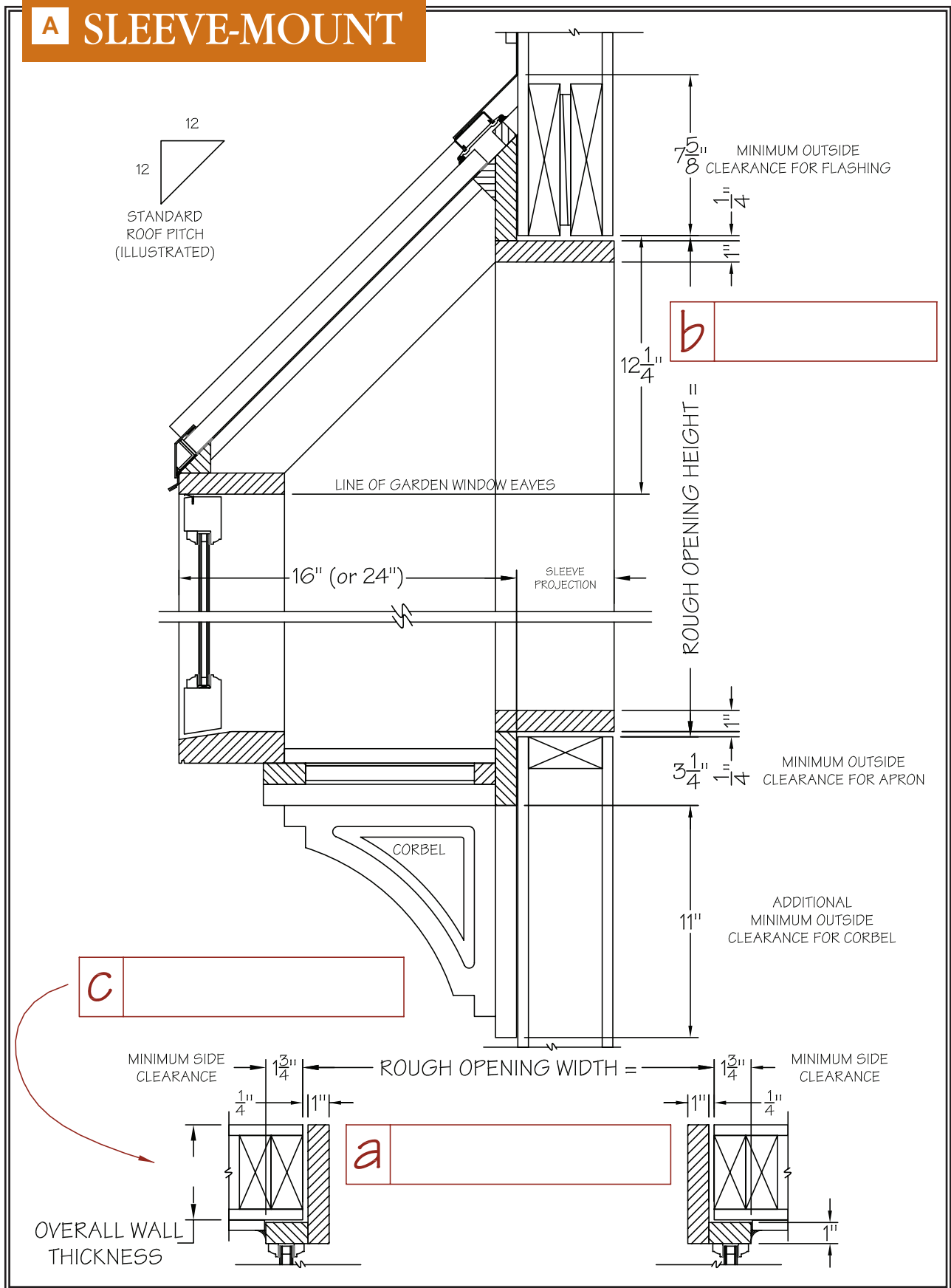

RENAISSANCE CONSERVATORIES

132 Ashmore Drive, Leola, PA 17540
 800-882-4657 717-661-7520 Fax 717-661-7727
 www.RenaissanceConservatories.com

PLEASE SIGN AND DATE TO PROCEED.

Customer's Signature

Date

B FACE-MOUNT

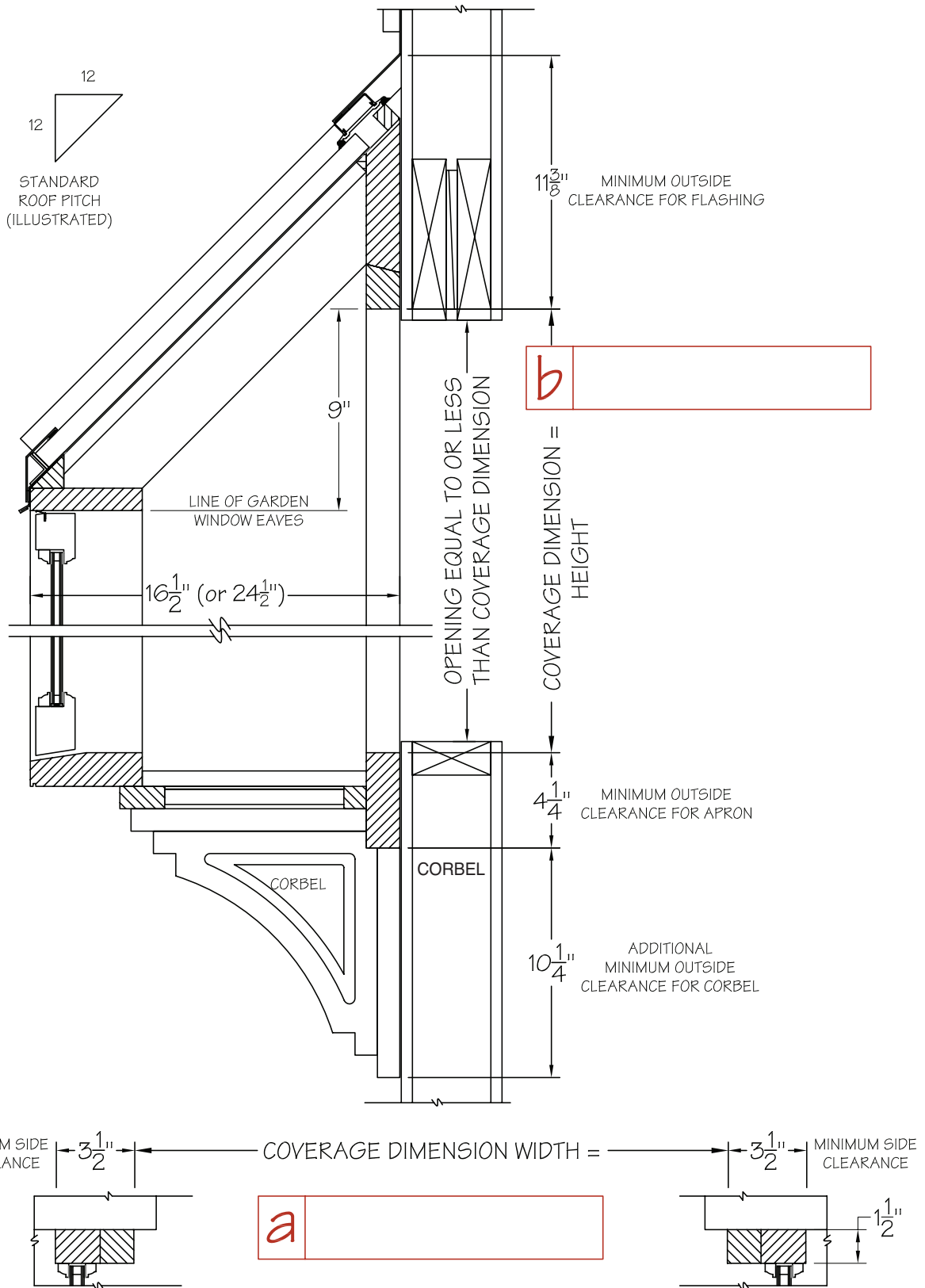

RENAISSANCE CONSERVATORIES

132 Ashmore Drive, Leola, PA 17540
 800-882-4657 717-661-7520 Fax 717-661-7727
 www.RenaissanceConservatories.com

PLEASE SIGN AND DATE TO PROCEED.

Customer's Signature

Date

C SLEEVE-MOUNT
Counter Top Extension

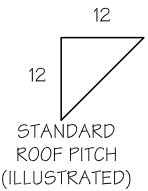
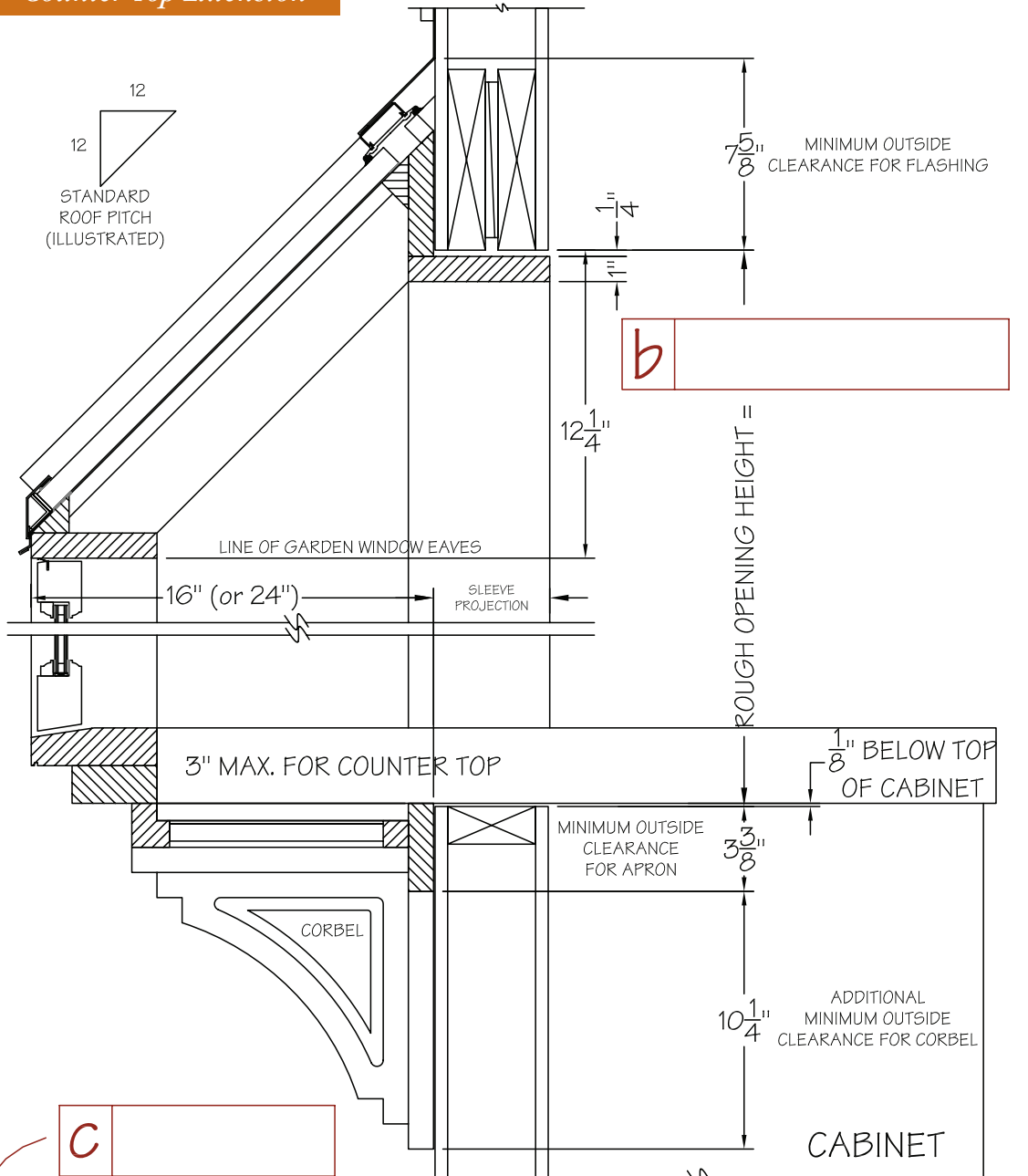

b

c

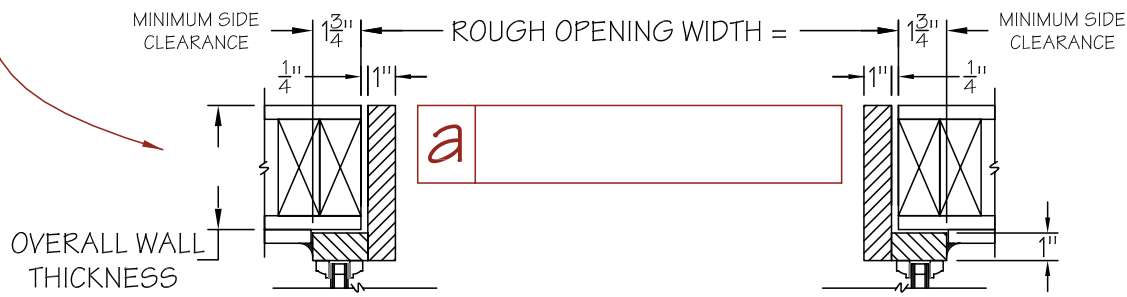

a

RENAISSANCE CONSERVATORIES
132 Ashmore Drive, Leola, PA 17540
800-882-4657 717-661-7520 Fax 717-661-7727
www.RenaissanceConservatories.com

PLEASE SIGN AND DATE TO PROCEED.

Customer's Signature

Date

D **FACE-MOUNT**
Counter Top Extension

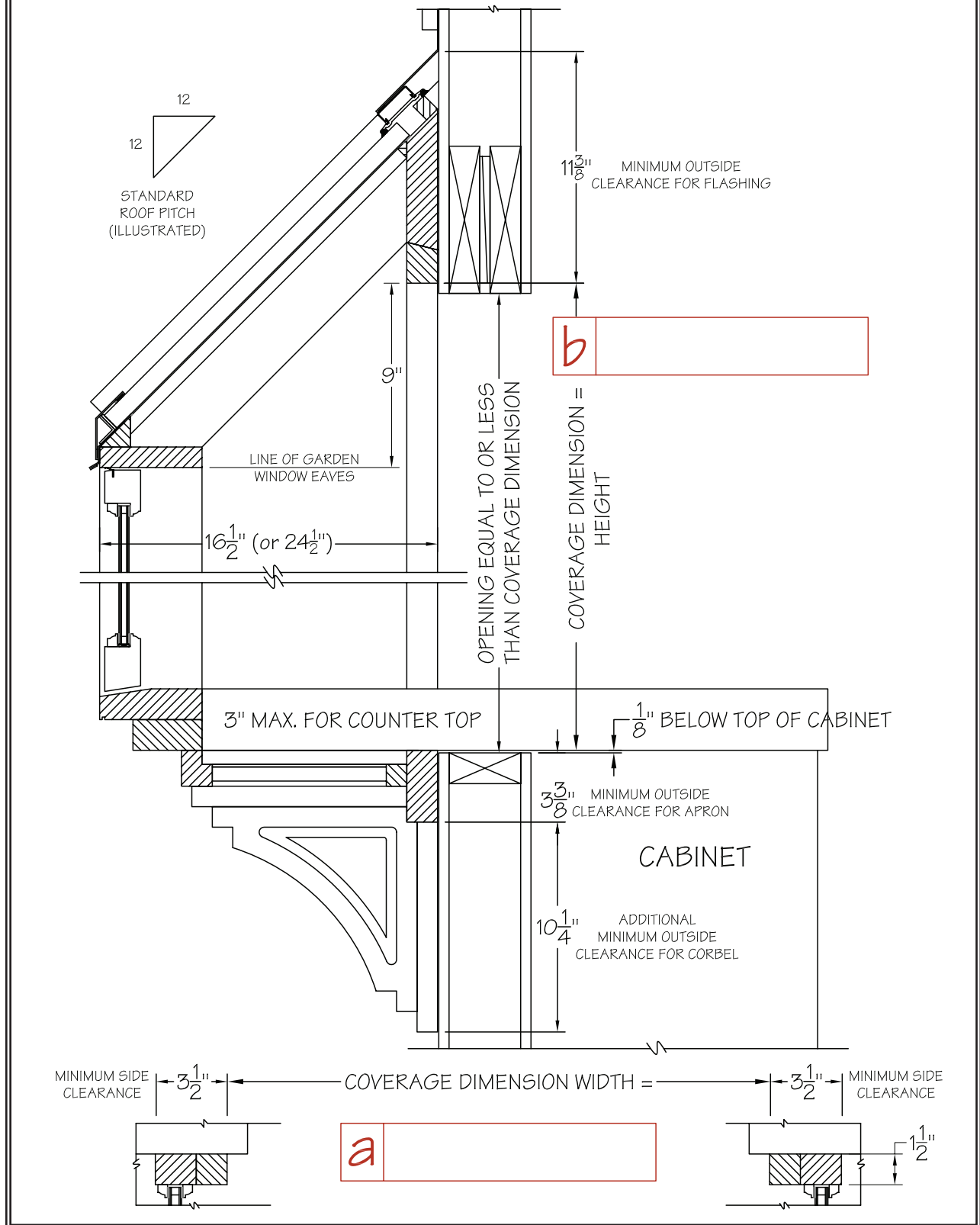

RENAISSANCE CONSERVATORIES

132 Ashmore Drive, Leola, PA 17540
800-882-4657 717-661-7520 Fax 717-661-7727
www.RenaissanceConservatories.com

PLEASE SIGN AND DATE TO PROCEED.

Customer's Signature

Date

6 DETAILS - E

E CUSTOM ROOF PITCH

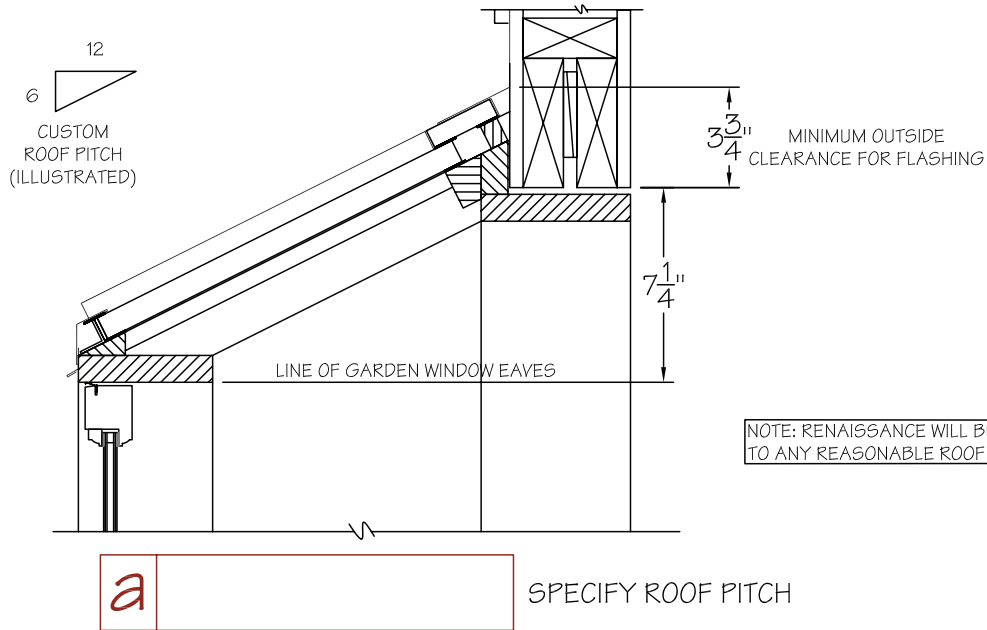

8 DETAILS - F

F

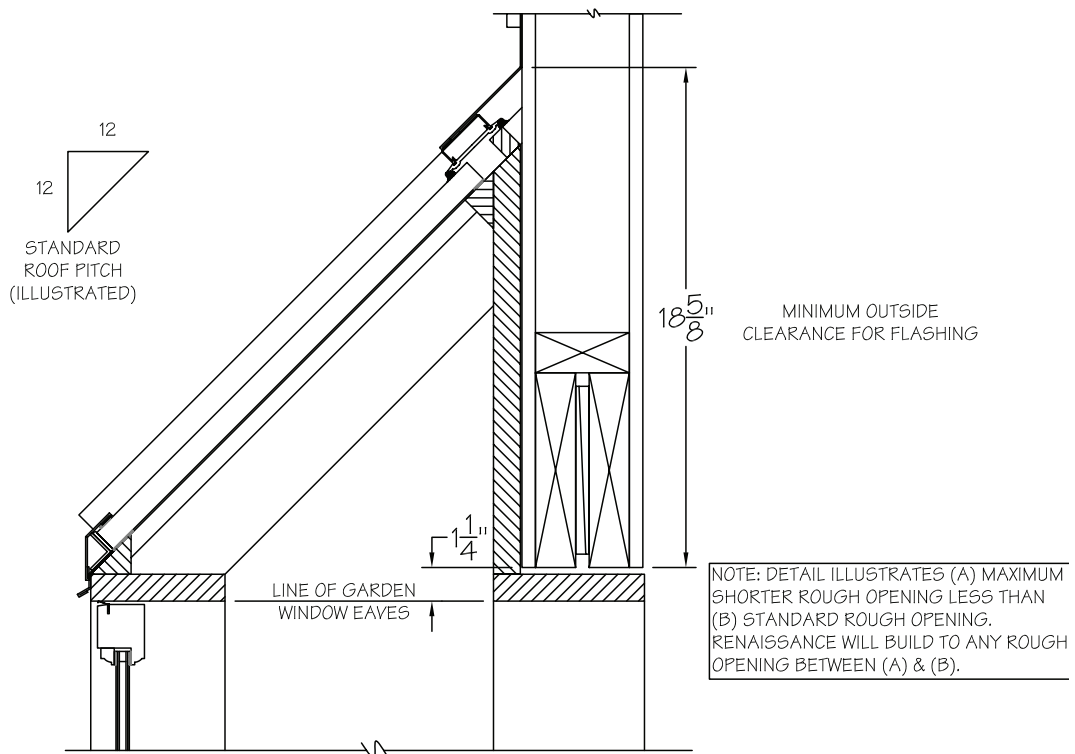

RENAISSANCE CONSERVATORIES

132 Ashmore Drive, Leola, PA 17540
 800-882-4657 717-661-7520 Fax 717-661-7727
 www.RenaissanceConservatories.com

PLEASE SIGN AND DATE TO PROCEED.

Customer's Signature

Date